

DATE
October 28, 2022

ATTN: Elizabeth Carter

THE STATE OF SOUTH CAROLINA

RECEIVED

Oct 28 2022

SC Court of Appeals

In THE Court of Appeals

Appeal FROM CHEROKEE COUNTY

Court of Common Pleas

J. Darlam Cole, Circuit Court Judge

Case No. 2021-000050

Bobby Dean Littlejohn

vs

Appellant
Respondent

Teck One Auto

Motion Request FOR Continuance

I am writing to ask the court to grant a continuance and in support of that motions showing the court the following: (1) Appellant need additional time TWO (2) months due to many medical situations concerning Me Bobby Dean Littlejohn (Appellant). (2) Additional time TWO (2) months is needed to prepare final Brief and to file the record on Appeal. (3) During the month My family had death in the family. My Nephew. I Bobby Dean Littlejohn (Appellant) Grieve the loss of my nephew. (The entire family does) and I've grieve for over 3 years Now for what Teck one Auto (Respondent) does to My Truck

WHEREFORE, The Appellant respectfully request that this court grant Order for a continuance until a later date and for such relief the Court deems just and Proper.

Bobby Dean Littlejohn
 BOBBY DEAN LITTLEJOHN
 109 VERMONT DRIVE
 GAFFNE, SC 29341
 864-812-1176

FOR Case NO. 2021-000050

Bobby Littlejohn
Appellant

Date: March 23, 2020
To: Cherokee County Magistrate
Re: Civil Case Number 2020CV1110100688
From: Tech One Auto Repair/Scott Lawhorn

I, Brian Scott Lawhorn, was served with a Complaint on March 5, 2020. My Answer is as follows: I deny that I am responsible at all because, in no way, did I damage the vehicle in question or remove any items from the vehicle that Bobby Littlejohn claims are missing. Here is my summary of events specific to this complaint:

10/31/2019:

- Bobby Littlejohn brought a 2006 Dodge Ram 1500 to my shop that morning around 9:30 – 10:00 as previously scheduled for repairs, specifically because it had a starting issue.
 - This was my first time ever working on this truck for Bobby.
 - Bobby stated that he had recently purchased this vehicle and that someone else had been trying to fix it. He feared that if the truck was cut off, it might not start back. Therefore, once at the shop, it was placed directly in a shop bay.
- The truck was checked and parts were ordered later that afternoon. During this time, the truck remained in a work bay. The parts were installed.
- Bobby Littlejohn was contacted near the end of the working day to pick up the repaired vehicle. He provided instructions to leave the vehicle outside and that he would pick it up after hours. I did this
- We finished working on this day between 6:15-6:30 and left for the day.

Week of 11/04/19:

- Bobby returned to shop:
 - He asked me if we had lights outside the shop. I answered "yes". Both of my employees, Parker Lecroy and Dale Harris, later clarified that he meant "cameras" not lights and that Bobby had complained to them that something was missing out of his truck.
 - He later explained to me that someone had stolen his console. Together, we went to his truck.
 - The console was not missing. His console was in his truck.
 - He said that someone had stolen his console and replaced it, that the one in his truck now was cracked, was 2 different colors and was missing a cup holder and Chicago Bears decals that were stuck to the bottom of the console.
 - I discussed this with Bobby and explained that no one had removed/replaced his console.
 - Bobby told me that it was like "the one in a truck in your parking lot that didn't have a tag on it"
 - Later that day, both of my employees explained to me that Bobby was referring to another Dodge Ram 1500 in my parking lot that belonged to another customer.
 - I actually had this truck at my shop for an extended period of time for major repairs on the engine. So, each time Bobby came back with a complaint, I used this truck as a reference because it was the same year, had the same interior and the same wear patterns consistent with a truck that is 13-14 years old.
 - After hearing this from my employees and knowing that I still had this truck at my shop, I was able to go look at this truck and realized that the interior in this truck was identical to the interior in Bobby's truck. I also realized that the cup holder was located in the dash, not in the console.
 - After seeing this, I felt confident that Bobby was just confused about the location of the cup holder because the truck was new to him. I honestly thought that once I showed and explained this to him that this matter would be resolved.

FOR Case No. 2021-000050
Bobby Dean Littlejohn

STATE OF SOUTH CAROLINA)
COUNTY OF CHEROKEE)
Bobbie Littlejohn,)
APPELLANT,)
VS)
Tech One Auto)
RESPONDENT.)

IN THE COURT OF COMMON PLEAS
020CP-110653

RETURN

IN THE MAGISTRATE'S COURT
2020CV1110100688

FILED IN OFFICE OF
CLERK OF COURT
CHEROKEE COUNTY, S.C.
2020 SEP 10 AM 11:38
BRANTLEY W. HOBBEE

DATE OF HEARING: August 6, 2020
TRIAL JUDGE: Robert B. Howell
ATTORNEY FOR APPELLANT: Pro Se
ATTORNEY FOR RESPONDENT: Pro Se

This matter came before the Court on August 6, 2020 pursuant to a Summons and Complaint filed by the Appellant. The Respondent filed a timely answer denying all allegations.

The Appellant testified: that he took his truck to the Respondent, who had done work for the Appellant in the past many times, to have some cosmetic repairs done to his truck. The Appellant further testified that the Respondent had damaged his truck by taking items off his truck and not replacing them (Chicago Bear Decals), completely changing out the trucks' interior and had put holes in the roof of the truck.

The Appellant further called five (5) witnesses that he had subpoenaed 1. Isaac Bridges, 2. Joe Littlejohn, 3. T. J. Haney, 4. Terry Haney, and 5. James Byers all of which testified that the interior of the Appellant's truck was different from when he first purchased the truck however none of them could testify to the fact that the changes to the interior or the damages were done by the Respondent. None of the witnesses were present when the Appellant picked up his truck from the Respondent and all witnesses testified that significant time had passed from when they first saw the truck to long after the repairs by the Respondent were completed.

The Appellant did not testify to any damages or put any exhibits into evidence.

The Respondent (Scott Lawhorn) testified that he nor his business did any damage to the Appellant's truck. The Respondent further that when the Appellant picked up his truck he was satisfied with the repairs that were made.

The Court found for the Respondent.

Gaffney, South Carolina
September 10th, 2020

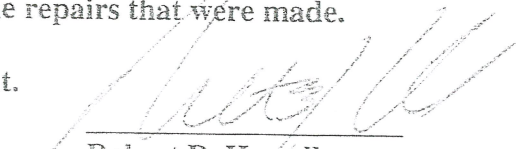

Robert B. Howell
Cherokee County Magistrate
Seventh Judicial Circuit

Motion
 Case NO. 2021-000050
 Bobby Dean Seibolke

Lancaster, SC

CARFAX History-Based Value Report

History events affecting this vehicle's value









 Personal Vehicle





 Accident Reported

\$9,080 Retail Value

CARFAX CARFAX® Vehicle History Report™
 An independent company established in 1986.

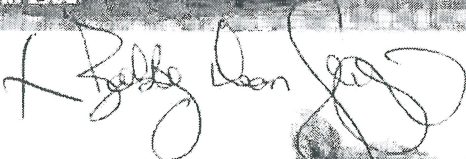
Vehicle Information:
 2006 DODGE RAM 1500 ST/SLT
 VIN:1D7HA18236S688364
 4 DOOR EXTENDED CAB PICKUP
 5.7L V8 F 16V
 GASOLINE
 REAR WHEEL DRIVE
Standard Equipment | Safety Options

-  Accident reported
-  2 Previous owners
-  5 Service history records
-  Personal vehicle
-  Last owned in South Carolina
-  157,032 Last reported odometer reading

This CARFAX Vehicle History Report is based only on information supplied to CARFAX and available as of 7/18/19 at 4:15:46 PM (CDT). Other information about this vehicle, including problems, may not have been reported to CARFAX. Use this report as one important tool, along with a vehicle inspection and test drive, to make a better decision about your next used car.

CARFAX Ownership History

	Owner 1	Owner 2
Year purchased	2006	2014
Type of owner	Personal	Personal
Estimated length of ownership	6 yrs. 10 mo.	5 yrs. 2 mo.
Owned in the following states/provinces	Louisiana	South Carolina
Estimated miles driven per year	22,072/yr	1,576/yr
Last reported odometer reading	153,272	157,032

	Spartanburg, SC 864-574-3011 cottman.com	
06/30/2017	South Carolina Motor Vehicle Dept. Gaffney, SC Title #770110280692556	Registration issued or renewed
06/27/2018	South Carolina Motor Vehicle Dept. Gaffney, SC Title #770110280692556	Registration issued or renewed
10/10/2018	South Carolina Motor Vehicle Dept. Gaffney, SC Title #770110280692556	Title issued or updated Loan or lien released
07/08/2019	South Carolina Motor Vehicle Dept. Gaffney, SC Title #770110280692556	Registration issued or renewed

Have Questions? Consumers, please visit our Help Center at www.carfax.com. Dealers or Subscribers, please visit our Help Center at www.carfaxonline.com.



Accident Indicator

CARFAX receives information about accidents in all 50 states, the District of Columbia and Canada.

Not every accident is reported to CARFAX. As details about the accident become available, those additional details are added to the CARFAX Vehicle History Report. CARFAX recommends that you have this vehicle inspected by a qualified mechanic.

- According to the National Safety Council, Injury Facts, 2015 edition, 8% of the 254 million registered vehicles in the U.S. were involved in an accident in 2013. Over 74% of these were considered minor or moderate.
- This CARFAX Vehicle History Report is based only on information supplied to CARFAX and available as of 7/18/19 at 4:15:46 PM (CDT). Other information about this vehicle, including problems, may not have been reported to CARFAX. Use this report as one important tool, along with a vehicle inspection and test drive, to make a better decision about your next used car.

Louisiana Damage Reports:

- Provide an estimate of the extent of damage in its accident reports for the following:
 - SEVERE/TOTALED: The vehicle cannot be driven from the accident scene due to severe damage or an injury. This level of damage often results in a Salvage or Junk title.
 - MODERATE: The accident damage affects the operation of the vehicle and/or its parts. Examples include broken windows, trunk lids, doors, bumpers and tires.
 - MINOR: The accident damage does not affect the operation of the vehicle and should not compromise vehicle safety. Examples include dented bumpers, fenders, grills and body panels.
 - NO DAMAGE: The vehicle was not damaged.
- Are required if the estimated damage exceeds \$500

First Owner

When the first owner(s) obtains a title from a Department of Motor Vehicles as proof of ownership.

New Owner Reported

When a vehicle is sold to a new owner, the Title must be transferred to the new owner(s) at a Department of Motor Vehicles.

Ownership History

CARFAX defines an owner as an individual or business that possesses and uses a vehicle. Not all title transactions represent changes in ownership. To provide estimated number of owners, CARFAX proprietary technology analyzes all the events in a vehicle history. Estimated ownership is available for vehicles manufactured after 1991 and titled solely in the US including Puerto Rico. Dealers sometimes opt to take ownership of a vehicle and are required to in the following states: Maine, Massachusetts, New Jersey, Ohio, Oklahoma, Pennsylvania and South Dakota. Please consider this as you review a vehicle's estimated ownership history.

337-942-1241
 saveatsterling.com/
 3.7
 26 Verified Reviews

06/26/2008

Louisiana
 Damage Report

Accident reported
 Involving rear impact
 Vehicle towed

Bobby Lee Fisher



Damage Location

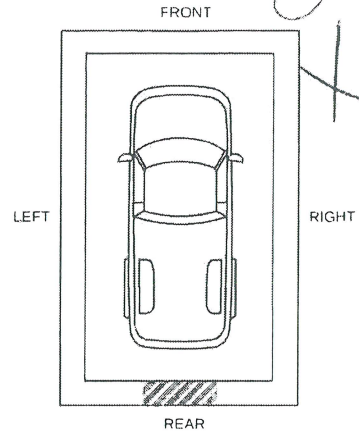

09/30/2013

153,236 Auto Auction
 Southeast Region

Vehicle sold



Millions of used vehicles are
 bought and sold at auction
 every year.

04/21/2014

153,272 Auto Auction
 Southeast Region

Listed as a dealer vehicle
 Vehicle sold

Owner 2
 Purchased: 2014
 Type: Personal
 Where: South Carolina
 Est. miles/year: 1,570/yr
 Est. length owned: 5/9/14 - present (5 yrs. 2 mo.)

Low mileage!
 This owner drove less than the industry average of 15,000 miles per year.

Date:	Mileage:	Source:	Comments:
05/09/2014		South Carolina Motor Vehicle Dept.	Vehicle purchase reported
06/20/2014	153,314	South Carolina Motor Vehicle Dept. Gaffney, SC Title #770110280692556	Title issued or updated Registration issued or renewed New owner reported Loan or lien reported
03/14/2016	156,502	Spartanburg Chrysler Dodge Jeep RAM Spartanburg, SC 864-580-2400 spartanburgcdj.com 3.3 6 Verified Reviews	Left airbag assembly replaced Computer reprogrammed Electrical system checked
03/21/2016		South Carolina Motor Vehicle Dept. Gaffney, SC Title #770110280692556	Registration issued or renewed
08/18/2016		South Carolina Motor Vehicle Dept. Gaffney, SC Title #770110280692556	Registration issued or renewed
10/28/2016	157,032	Cottman Transmission	Vehicle serviced



Title History

CARFAX guarantees the information in this section

Owner 1

Owner 2

Salvage | Junk | Rebuilt | Fire | Flood | Hail | Lemon

Guaranteed
No Problem

Guaranteed
No Problem

Not Actual Mileage | Exceeds Mechanical Limits

Guaranteed
No Problem

Guaranteed
No Problem



GUARANTEED - None of these major title problems were reported by a state Department of Motor Vehicles (DMV). If you find that any of these title problems were reported by a DMV and not included in this report, CARFAX will buy this vehicle back. [Register](#) | [View Terms](#)



Additional History

Not all accidents / issues are reported to CARFAX

Owner 1

Owner 2

Total Loss

No total loss reported to CARFAX.

No Issues
Reported

No Issues
Reported

Structural Damage

No structural damage reported to CARFAX.

No Issues
Reported

No Issues
Reported

Airbag Deployment

No airbag deployment reported to CARFAX.

No Issues
Reported

No Issues
Reported

Odometer Check

No indication of an odometer rollback.

No Issues
Indicated

No Issues
Indicated

Accident / Damage

Accident reported on 06/26/2008.

Accident
Reported

No New Issues
Reported

Manufacturer Recall

No open recalls reported to CARFAX.

No Recalls
Reported

No Recalls
Reported



Detailed History

History

Owner 1	Date:	Mileage:	Source:	Comments:
Purchased: 2006 Type: Personal Where: Louisiana Est. miles/year: 22,072/yr Est. length owned: 11/21/06 - 9/30/13 (6 yrs, 10 mo.)	07/19/2006	5	Sterling Automotive Opelousas, LA 337-942-1241 sterlingautomotivegr oup.com 3.7 26 Verified Reviews	Pre-delivery inspection completed Spare tire lock installed
	10/09/2006	6	Sterling Automotive Opelousas, LA 337-942-1241 sterlingautomotivegr oup.com 3.7 26 Verified Reviews	Vehicle serviced
	10/23/2006		Sterling Automotive Opelousas, LA 337-942-1241 sterlingautomotivegr oup.com	Vehicle sold
	11/21/2006	54	Louisiana Motor Vehicle Dept. Eunice, LA	Title issued or updated First owner reported Titled or registered as personal vehicle Loan or lien reported
	01/15/2007	5,025	Sterling Automotive Opelousas, LA	Oil and filter changed

RECEIVED

Oct 28 2022

SC Court of Appeals

October 28, 2022

The State of South Carolina
In the Court of Appeals

Court of Common Pleas
J. Durham, Circuit Court Judge

Case No: 2021-000050

Bobby Dean Littlejohn vs. Appellant
Tech One Auto Respondent

Proof OF Service

I certify that I have served the Request For Continuance and Motions to Tech One Auto / Scott Lawhorn by Email ^(pro) Techone@Techoneauto.net on October 28, 2022

cc. The South Carolina Court of Appeals

Email Ctappfilings@SCCourts.DRg

cc Joe Meil Littlejohn

Email Joe Meil 218@gmail.com

cc. Bobby Dean Littlejohn

bobbyd.littlejohn@gmail.com

Also
Sent picture of \$50 money order
for filing fee To Tech One Auto / Scott
Techone@TechoneAuto.net
Lawhorn

Bobby Dean Littlejohn
BOBBY DEAN LITTLEJOHN
109 VERMONT DRIVE
GAFFNEY SC 29341
864-812-1176